

STRANGE PETIT

3.0

27 - Sep-2019

3.0 LED

LED 3x6W | 350mA | COB 3-step | excl. power supply

CE IP20 10.3m 31° 25°/25° 355°

white texture	163361W
black texture	163361B

LIGHT COLOUR

2700K >90CRI 3x460lm 18V	3
3000K >90CRI 3x490lm 18V	5
1800-2700K >95CRI 3x330lm 15V	9

ALWAYS USE

plastic plaster kit	
white	90017206
black	90017207
aluminium plaster kit	
aluminium	90017208

Please see our catalogue for power supplies

plaster kit (has to be ordered separately)

90017208
Aluminium plaster kit

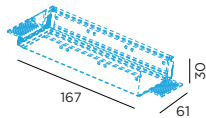

90017206 / 90017207
Plastic plaster kit

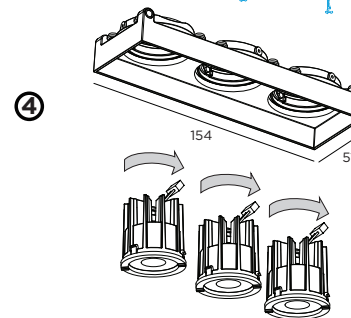
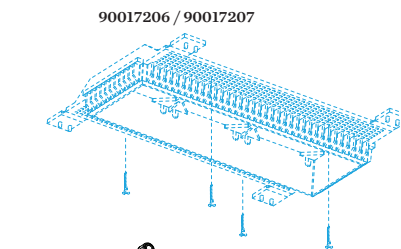
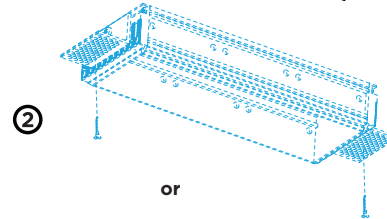
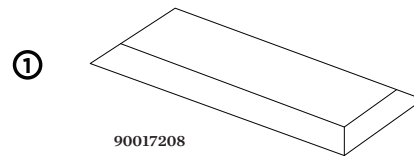
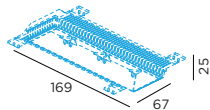

DIMENSIONS

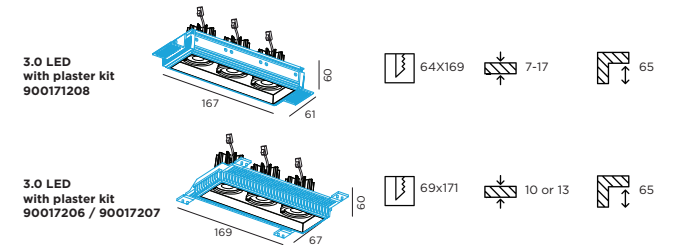

MOUNTING INSTRUCTION

- ① Make a hole in the ceiling according to the prescribed dimensions. The plaster kit is always needed.
- ② Insert the plaster kit through the ceiling hole under an angle. Fix the plaster kit with screws through the ceiling plates aiming in the perforated area. Plaster the borders seamlessly.

POWER CONNECTION

- ③ SERIAL CONNECTION - for LED
Always use a power supply according to the specifications of the LED module.

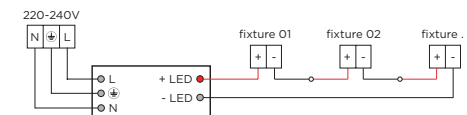

- ④ Insert the housing in the installed plaster kit and lock the LED module into the housing by a quarter turn.



WEVER & DUCRÉ
LIGHTING

www.weverducre.com

Wever & Ducré bvba Spinnerijstraat 99/21 8500 Kortrijk

INSTALLATION
INSTRUCTIONS

PAGE 1/2

STRANGE PETIT 3.0 PLASTER KIT

27 - Sep-2019

plastic plaster kit

white
black

90017206
90017207

plaster kit (has to be ordered separately)

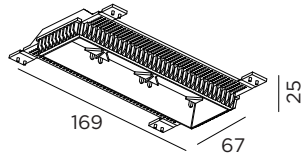

Note: there are 4 flexible legs on the plaster kit.

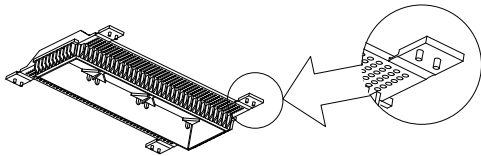

When the plaster board thickness is 13mm,
the legs can be left opened.

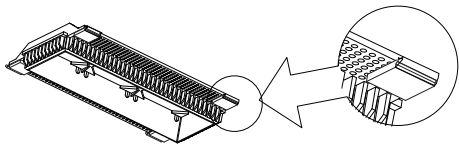

When the plaster board thickness is 10mm,
the legs have to be folded.

①

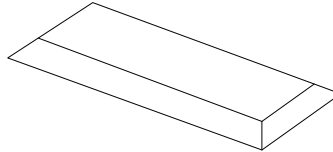

②

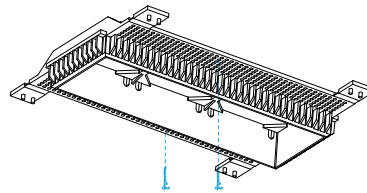

④

