

# CHANDELIER

design David Chipperfield, 2004

FontanaArte

90 cm / 35,40"

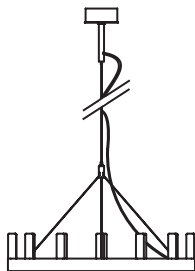

500 cm / 196,85"

cod. UL5491..

14x40W E11

Ø 90 x 500 cm

Ø 35,40 x 196,85"

150 cm / 59,05"

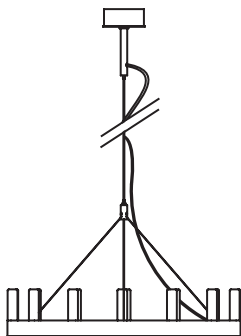

500 cm / 196,85"

cod. UL5491/1..

19x40W E11

Ø 150 x 500 cm

Ø 59,05" x 196,85"

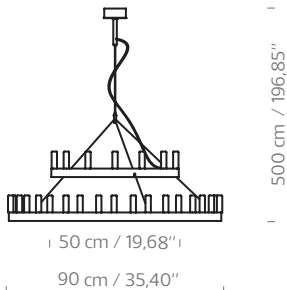

cod. UL5491/22..

8 + 14x40W E11

Ø 50-90 + 500 cm

Ø 19,68" + 35,40" x 196,85"

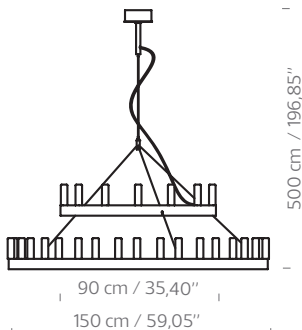

cod. UL5491/33..

14 + 19x40W E14

Ø 90 - 150 + 500 cm

Ø 35,4 - 59,05" + 196,85"



1

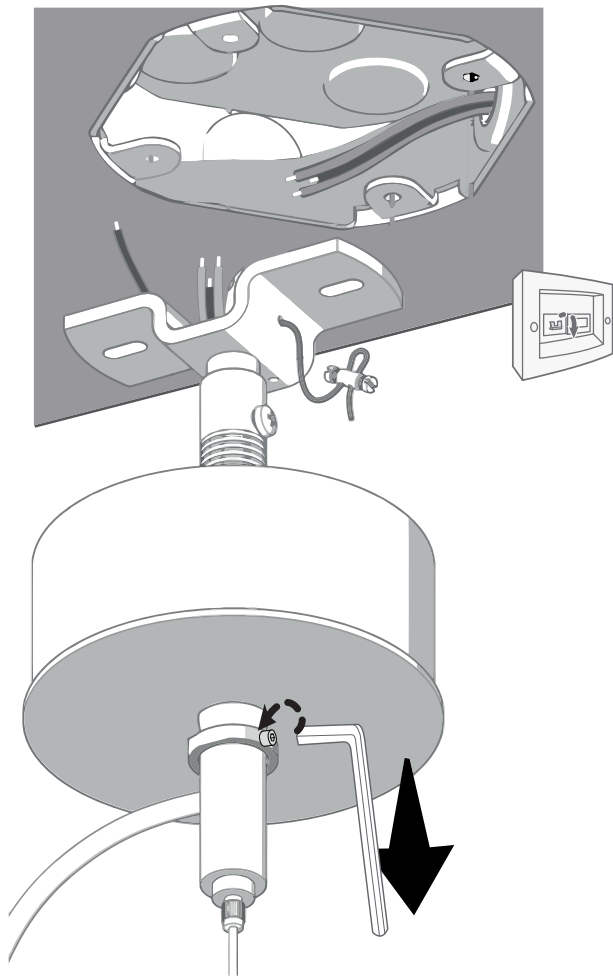

2

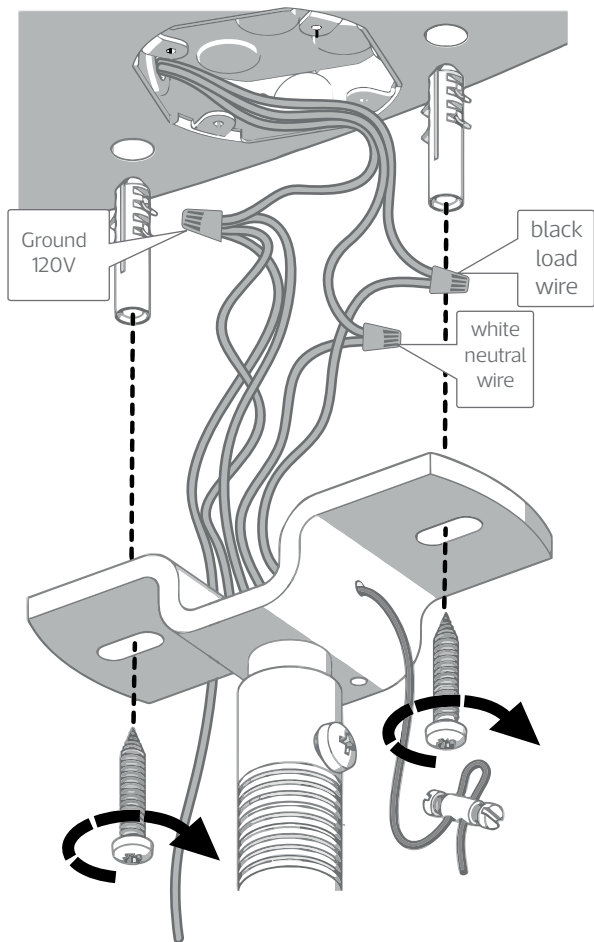

3

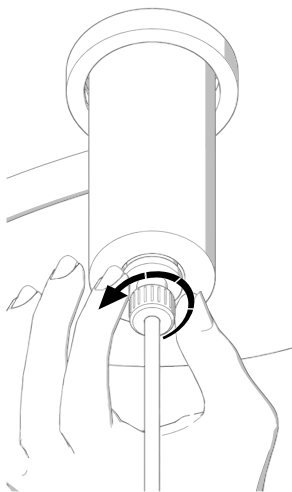

4

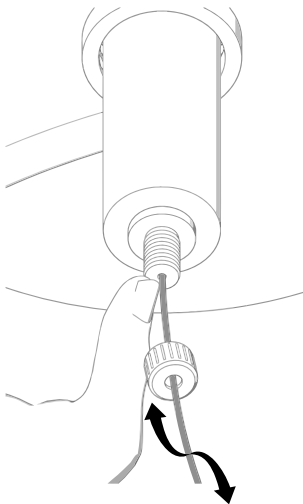

5

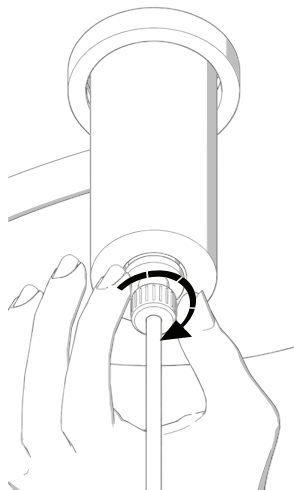

6

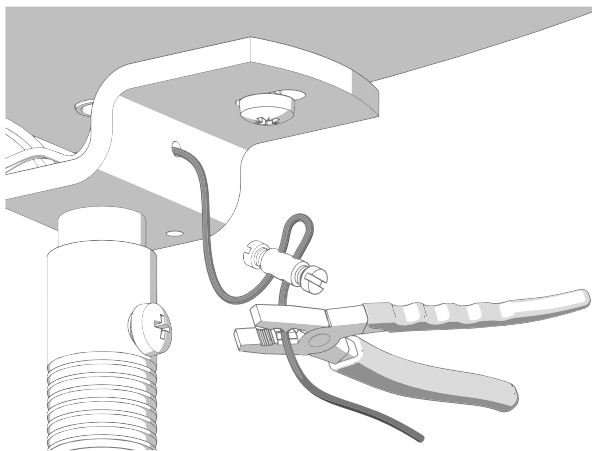

7

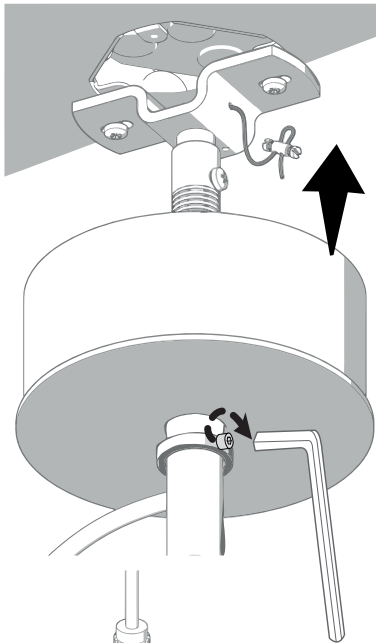

8

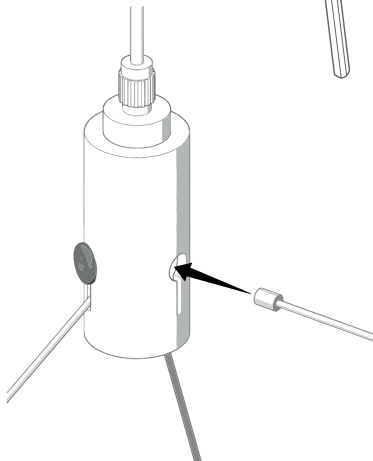



9

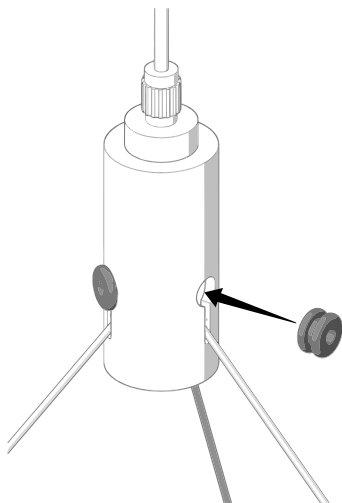

10

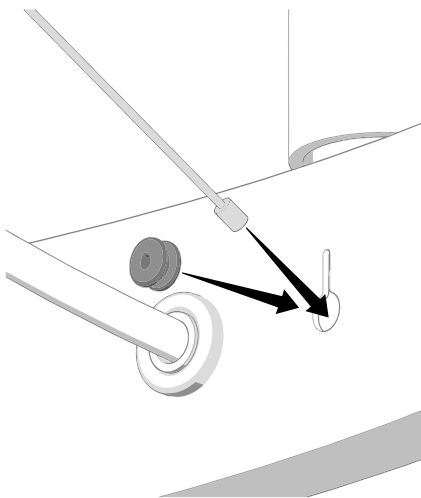

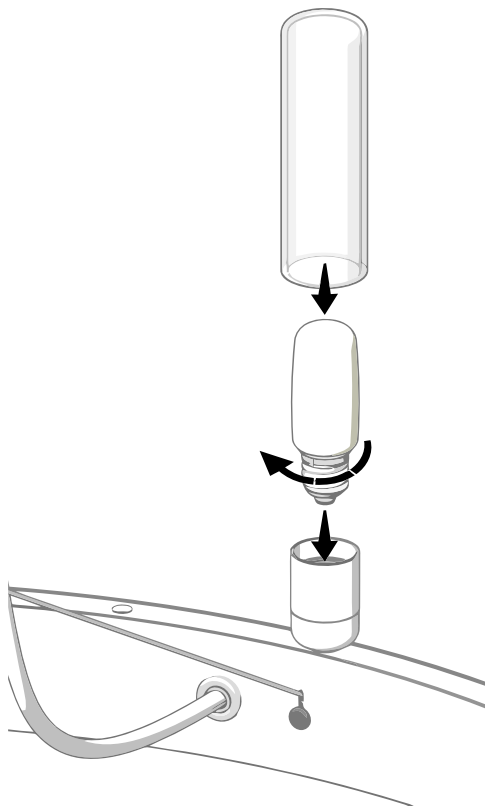

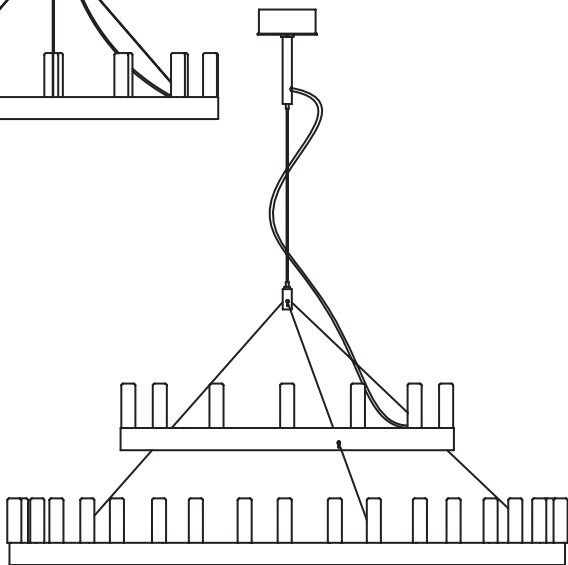
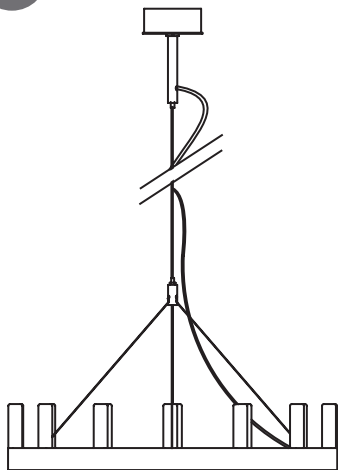

FontanaArte  
Alzaia Trieste, 49  
20094 Corsico (MI), Italia  
Ph. +39 02 45121  
info@fontanaarte.com  
www.fontanaarte.com

cod. 009054911