

Smart Cake 82 IP LED Warm Dim GE

124140XX_124141XX_124142XX

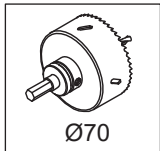

Lorem ipsum

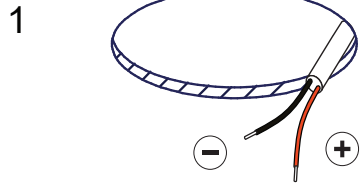
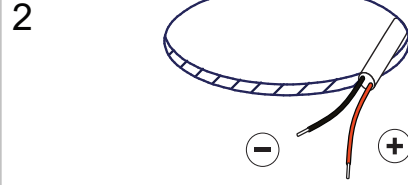
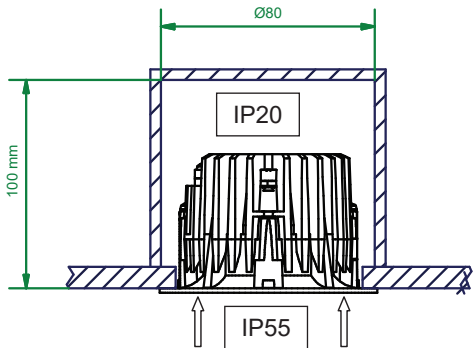

Drive Current (mA)	Forward Voltage		Power (W)
	min (Vf)	max (Vf)	
350	15,5	18,5	6
For serial connection, respect polarity!			
⊕ RED		⊖ BLACK	

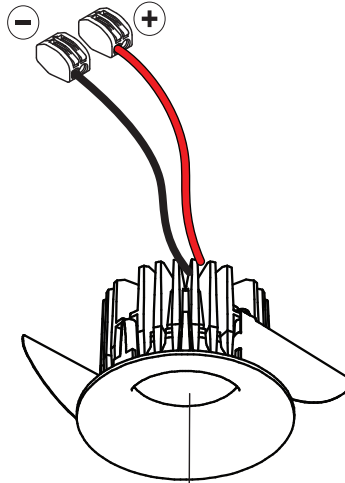

Replace protective shield when broken. The luminaire shall only be used complete with its protective shield. Reference number: 1010754

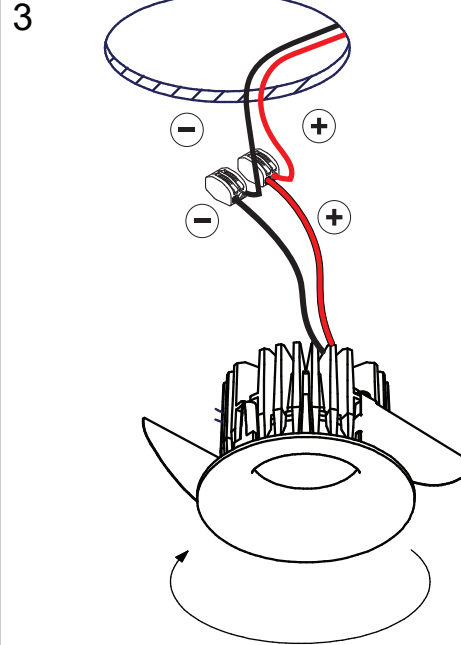

install : Twist clockwise
 uninstall : Twist counterclockwise

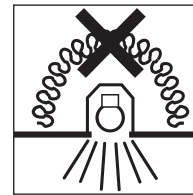

The light source contained in this luminaire shall only be replaced by the manufacturer or his service agent or a similar qualified person

CAN BE USED WITH

Drivers:
 see driver matrix - latest version on website
www.supermodular.com or check sales contact

Recessed ring:
 12500230 Recessed ring Ø70 H100

Gypkit - conbox
 12290130 Gypkit 190X190X Ø70
 10889830 Conbox outer dim. 190x192x130

Mask:
 12500009 Smart Mask 82 1x WhStr
 12500032 Smart Mask 82 1x B1Str
 12500046 Smart Mask 82 1x Gold
 12500109 Smart Mask 82 2Lx WhStr
 12500132 Smart Mask 82 2Lx B1Str
 12500146 Smart Mask 82 2Lx Gold

